

AURORA SHELVING PLANNING GUIDE



Questions to Ask When Planning a Storage or Filing System

1. What is being stored? Files, books, binders, X-Rays, evidence storage, computers, CD's, parts, tapes, banker boxes, etc.
2. What are the dimensions of what is being stored? This will determine your clearance of the openings.
3. If working with files: are they letter, legal, or X-Ray? Are the folders top tab, side tab, or hanging?
4. What is the capacity you are trying to achieve? (including expansion) How thick are the files? How much growth do you anticipate?
5. How much space is available? Ceiling height, columns, and impediments of any kind? Room layout available? (Remember to consider sprinklers, fire codes, and seismic requirements.)
6. Are aesthetics important?
7. Is security important? Doors, security locks on mobile, restricted access?

TABLE OF CONTENTS

AURORA SHELVING PLANNING GUIDE

Questions to Ask When Planning a Storage or Filing System	i
Table of Contents	ii

THE AURORA SHELVING CONCEPT 1

Easy Assembly	2
The Aurora Shelving Family	3
Part Numbering Guide and Glossary	4
The Advantages of Aurora Shelving	5
Upright Styles	6

AURORA QUIK-LOK® SHELVING 7

Aurora Flat Files™	8
Aurora Wide-Lok™ Wide Span	8
Specialty Storage	9
Accessories	10,11
Aurora Storage System with Plywood Shelves	12

AURORA LIBRARY SHELVING™ & WOOD-TEK™ LIBRARY SHELVING 13

Aurora Library Shelving - 4 Post vs Cantilever Debate	14
Selection Guide for Aurora Library	15
Library Configuration Styles	16
Ordering Laminate Tops for Library Shelving	17
Laminate End Panels and Backs	18
Aurora Library Accessories	19,20

AURORA SHELF FILING 21

Aurora X-Ray Shelving™	22
Aurora Shelf Filing Components	23
Filing Drawer Configuration Chart	24
Divided Drawer Configuration	25
Shelving Adjustability Chart	26
Filing Inch / Square Footage Comparison Chart	27

INNOVATIONS IN STORAGE SYSTEMS

Aurora was the first to create and patent the Quik-Lok 4-Post Shelving design with no sway braces or hardware to damage the items being stored. This innovation also allows for easy and quick assembly for every style of our shelving.

Aurora Shelving is flexible enough to store files, books, office supplies, weapons, evidence, industrial parts or retail goods. Try doing all that in lateral file cabinets!

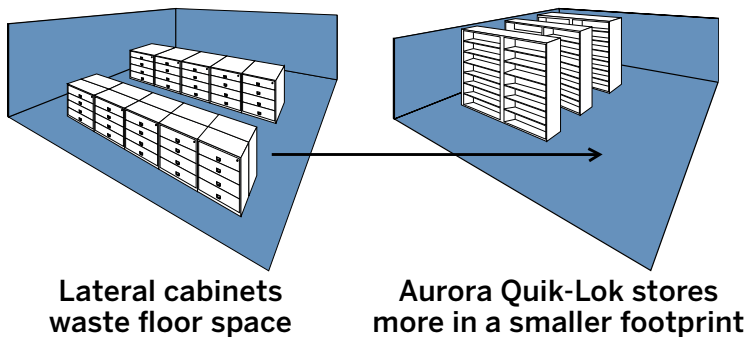

Aurora Shelving saves space and provides great accessibility. Compare this floor plan with lateral cabinets versus Aurora Shelving. You can save 50% or more of floor space to add more workstations or more storage.

Loads of accessories make Aurora Shelving your top choice for design flexibility from basic shelving to drawers, security doors, bins, reference shelves, and many other options. Aurora Shelving can also be placed on mobile carriages to make a high density storage system.

The total value of Aurora Shelving encompasses easy assembly, outstanding quality, and superior strength all backed by a Limited Lifetime Warranty.

The Aurora Storage Concept: Three basic parts form a system of storage units

This concept is the basis for the products in the full line of Aurora Shelving storage systems.

Just three basic parts form a system of storage units that simplify assembly for all Aurora shelving styles including standard shelving for filing and general storage, heavy duty shelving and library shelving—uprights, shelf supports, shelves.

Additional parts give added flexibility to Aurora Shelving units. These include Shelf Reinforcements, Closed Uprights, Backs, Doors, and Quik-Base™ to enclose each shelving unit.



1. UPRIGHT

(open T, or open L Uprights)

Each post has a double wall of steel with holes punched on the inner wall only. Exposed face is without holes and flush with shelf.

T post is 2" wide, with 2 rows of holes for common post construction. The L post is 1" wide with 1 row of holes for end post or unit-type construction.



2. SHELF SUPPORTS

Provide full width support under each shelf, front and back. Rivets on support fit into holes punched on the inner wall of upright posts.



3. SHELF

Shelves fit over shelf supports. No fastening required.

EASY ASSEMBLY

Fastest of all shelving. No hand tools needed. No sway braces, nuts, bolts, or clips.

Actual reported time to assemble Aurora Shelving is amazing.

Here's an example: One project had 42 sections of shelving assembled per hour based on a three person crew installing shelving with 9 shelves per section. That works out to 5-minute assembly per section.



1 POSITION UPRIGHT
Temporarily place one Shelf Support at any convenient location to properly space Uprights.



2 BUILD FROM THE BOTTOM UP
Place Shelf Supports or Quik-Base (front and back) for lowest shelf only.



3 FIT SHELF OVER SUPPORTS
Then add two more supports at the next shelf location, place shelf, and continue up the unit.



4 ADD EXTRA SECTIONS
Utilize common center Uprights. (An additional Upright must be used to add extra sections.)

THE AURORA STORAGE FAMILY OF STORAGE UNITS

All Aurora Shelving storage units give you these advantages:

- 1. Fast, easy assembly**
- 2. Heavy duty strength**
- 3. Modern, straight-line appearance**

No matter what your storage application, there's a unit ready to bring you the greatest efficiency at the lowest total cost. When you consider the assembly savings and versatility of Aurora Shelving products, their total value makes them the only choice over nut and bolt, or clip shelving.



Aurora Shelf Filing

Provides maximum storage in minimum space for economical, easy access open shelf filing.



Aurora Library Shelving

Brings attractiveness, strength and high visibility to book storage. No nuts, bolts, clips, or sway braces to snag books.



Aurora Quik-Lok Shelving

Meets storage needs for materials of all sizes and weights. Fastest assembly. Greatest strength.



Aurora Wide-Lok Wide Span Shelving

Designed to provide a strong, durable storage solution for larger and heavier objects.

PART NUMBERING GUIDE

Ordering Tips

The part numbering system for all Aurora Shelving Products describes the individual components or units in complete detail. This system will simplify your ordering and provide a visual check on the size of related parts. Following are general rules:

1. What do part numbers mean?
2. **Remember:** When using part numbers for shelving units, TWO Uprights are included for Starters and ONE Upright for Add-ons.
3. For each Shelf that you order you must have two Shelf Supports.
4. In the part number, the number of shelves includes the top shelf. To figure the number of openings subtract one from the number of shelves. Thus a 9 shelf unit has 8 openings.
5. Sliding Doors are available in 72" and 108" widths only—they will not fit on 36", 42", 48" wide units when standing by themselves.
6. When ordering extra Slotted Shelves with File Dividers, make certain that you also order a Backstop for single access and a Center Stop for double access.

EXAMPLE: Type of Shelving

TQ	Standard Quik-Lok® Shelving	
L	Library Shelving	
F	Open Shelf Filing	
2F	22 gauge Open Shelf Filing	
TX	X-Ray Shelving	

			Shelving Depth
			9" 18"
			10" 20"
			12" 24"
			13" 26"
			15" 30"
			16" 32"
			36"

Closed or Open

C	Closed shelving unit, i.e. Uprights are solid and unit has a Back except shelf filing.	
O	Open shelving unit, i.e. Uprights are open and unit has no Back.	
D	Double Entry (Double Wall & Library units only)	
B	Bin Divider	

L or T Upright

L	Denotes Starter unit	
T	Denotes Add-on unit	

Number of Shelves

Width of Unit in Inches

7. Shelves for open shelf filing have a ¾" profile and are available in either 18 or 22 gauge. Shelf Supports for open shelf filing have a ¾" profile and are available in 11 or 14 gauge.
8. Standard Quik-Lok® Shelves have a ¾" profile and are available in 18 and 22 gauge. Heavy Duty Supports have a 1¼" profile and are available in 11 and 14 gauge.

Glossary

AT	Aisle Tie	FF	Flat Files	RD	Retractable Door
B	Back	FHD	Full Height Divider (X-Ray)	RDL	Retractable Door w/Lock
BC	Bookcase	FHDDE	Full Height Divider (Double Entry) (X-Ray)	RLP	Hanging Bar Rails
BL	Back Stop (Library)	GAR	Garment Cabinet	RS	Reference Shelf
CB	Converter Bar	HF	Hanging Folder Package	RT	Reinforcement Open Shelf Filing
CF	Center Stop Slotted	L	Library Shelf	S	1¼" High Shelf Support
CL	Closed L Upright	LEP	Laminate End Panel	SB	Slotted Back Stop
CL	Center Stop (Library)	LF	Leveler Foot	SBPK	Drawer Slide Bracket Pack
CLS	Center Stop Slotted (Library)	LFS	Laminate Filler	SD	Sliding Door
COM	Combination Units	LHT	Label Holder Open Shelf	T	Non-Slotted Shelf
CP	Clothespin	M	Mobile Ready	TP	Punched Shelf
CQ	Center Stop (Standard Quik-Lok®)	MD	Magazine Door	TQ	Standard Quik-Lok® Shelving
CT	Closed T Upright	OL	Open L Upright	TS	¾" High Shelf Support
CX	Center Stop Slotted (X-Ray)	OT	Open T Upright	TX	X-Ray Shelving
DIV	Divider for Divided Drawer	PAR	Partition	WC	Wall Mounted Cabinets
DS	Double Slotted (X-Ray)	PF	Plastic Foot	WL	L Upright (Library)
D(xxxxxx)DWR	Divided Drawer	PS	Post Shim	WLF	L Upright 40¼" H (Library)
D(xxxxxx)DWRL	Divided Drawer w/Lock	QB	Quik-Base™	WS	Wire Book Support
F(xxxxxx)DWR	File Drawer	QD	Quik-Door™ w/Lever Handle	WSS	Wide Span Shelving
F(xxxxxx)DWRL	File Drawer w/Lock	QDR	Quik-Door™ w/Round Handle	WT	T Upright (Library)
F	Slotted Shelf	QR	Quik-Roll™	WT	Wall Tie
FD	File Divider	R	Reinforcement	WTF	T Upright 40¼" H (Library)

COMPARE THE MANY ADVANTAGES OF AURORA SHELVING

	THE AURORA SHELVING ADVANTAGE	CONVENTIONAL CLIP SHELVING
RIGIDITY	Rigidity without sway braces provides access from all sides and faster assembly. Excellent for double entry storage. Cleaner appearance, too.	Sway braces required for rigidity mean more assembly time and prevent double entry storage.
ASSEMBLY HARDWARE	No hardware required. Rivets quickly lock into keyhole slots, and shelves adjust on 1½" centers.	Clips required to secure shelving. Does not provide full width shelf reinforcement.
STRENGTH	Full width shelf supports. Unmatched strength and loading capacity.	Extra shelf reinforcements required when shelves will be subjected to moderate or heavy loading. Difficult to install in the field.
ECONOMICAL	Accepts chipboard or plywood shelves for further economy.	Does not offer economical advantage of accepting chipboard or plywood shelves.
EASE OF ASSEMBLY	Fastest assembly of any shelving using just 3 basic parts. No tools needed. Saves 30% compared to clip or stud types, 85% compared to nut-&-bolt types. Easy to disassemble & move, too.	Tools required for assembly and disassembly is just as time-consuming.



Aurora Quik-Lok Shelving



Old Style Clip Shelving

CHOICE OF UPRIGHT STYLES

All Aurora Shelving units can be assembled with either T Uprights (common post construction for adding more units) or L Uprights (for row ends). Photos show Standard Shelving; this same concept applies to Library Shelving.

Styles



L Upright

Used to dress up ends of rows and eliminate the 1" overhang at each row end.



T Upright

Used to gain advantages of common post construction and, with a modified panel, when wood or laminate end panels are desired.

Common Upright Configurations

Starter and Add-On with Closed Uprights



Top View of Closed L Upright, Closed T Upright

Starter and Add-On with Closed Uprights on Ends and Open Upright in Center



Top View of Closed L Upright, Open T Upright

Starter and Add-On with Open Uprights



Top View of Open L Upright, Open T Upright

AURORA QUIK-LOK SHELVING

Clean Line Design

One piece Back inserts between Uprights and is held in place without holes or bolts by its reverse flange edges.



One Piece Back

Supports & Adjustable Reinforcements

Shelf Supports (**Part A**) give full width reinforcement, front and back, on every shelf. Adjustable Shelf Reinforcements (**Part B**) are used to prevent deflection of the shelf and evenly distribute the weight load. They seat on Shelf Supports and can be positioned at specific points under the shelf to give support where needed most.



TS Supports are used with RT Reinforcements and are usually for lighter loads.



S Supports are used with R Reinforcements for heavier duty applications.

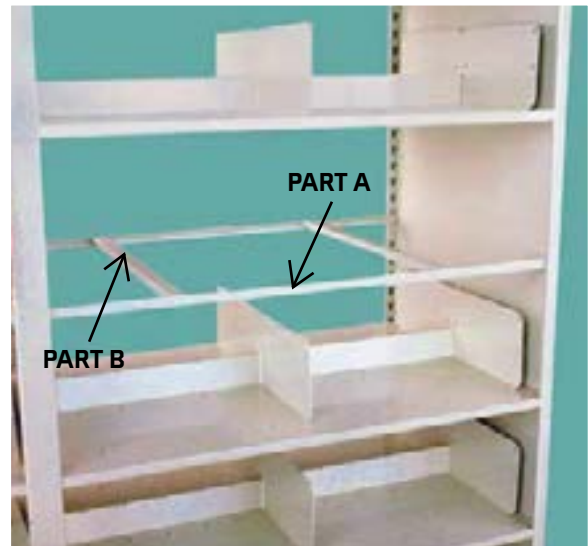

AURORA QUIK-LOK SHELVING

Aurora Flat Files™

Aurora heavy-duty welded flat files feature ball bearing slides and smooth drawer interiors with no catch points to harm material being stored. Files are made from 18 gauge cold rolled steel.

Features

- Five 2" Drawers with 100 lb. capacity
- Easy Glide Drawer with Dual Chrome Pulls
- Standard Label Holders, Optional Floor Bases
- Stack 3-High or Mount to Mobile Carriages

File Sizes

W	D	H
40½"	28½"	15½"
46½"	35½"	15½"
53½"	41½"	15½"

Optional Floor Bases

4" H	20" H
------	-------



Aurora Wide-Lok™ Wide Span

Aurora Wide-Lok™ Wide Span Shelving provides a strong, durable storage solution for larger and heavier objects such as:

- Bankers Boxes
- Museum Artifacts & Sculpture
- Large Police Evidence
- Military Ready Bags
- Bulk Storage

Our Wide-Lok Shelving uses standard closed uprights and features 8 shelf widths and 7 shelf depths. Just as with regular Quik-Lok Shelving, Wide-Lok assembles with minimal tools.

There are two options available with Special Beam and Stabilizers that allow for a wider span for weight loads from 1100-1800 lbs. for 1800 Series and 510-1100 lbs. for 1100 series.

Features:

- Two Wide Span Options - 1800 Series & 1100 Series
- Sturdy 3" Beam & Stabilizer Package
- Decking Options Include:
 - Steel or End User Supplied Plywood
- Mix Wide-Lok with Aurora Standard Shelving
- Mobile Ready Option
- Colors match to all Aurora Products including Shelving, Mobile, Times-2, and Museum Cabinets

Wide-Lok Sizes

Decking Depths	15",18", 24", 26",30",32",36"
Decking Widths	54",60",66",72", 78", 84",90",96"
Upright Heights	40¼", 64¼", 76¼", 85¼", 88¼", 97¼", 100¼", 121¼"

SPECIALTY STORAGE



Box Storage on Quik-Lok Shelving

Just as Wide-Lok Shelving is a great solution for longer spans of box storage, Aurora Quik-Lok Shelving is also perfect for this type of high density specialized storage. Either style of shelving can feature spliced uprights to reach taller heights. Space planning for box storage uses shelving spaced on 12" centers with 6 openings at 76 $\frac{1}{4}$ " H or 7 openings at 88 $\frac{1}{4}$ " H shelving on 42" wide sections. Depth will vary depending on the length of the banker boxes.



Bin Dividers & Punched Shelves

Bin Dividers are used with Punched Shelves to create cubbies for mail sorting, form storage, small parts, retail storage, and more.

Bin Dividers

Depths: 12", 18"

Heights: 6", 9", 12", 16 $\frac{1}{2}$ "

Oversized Bin Dividers

Available for organizing larger items in the following sizes.

Punched Shelves

Widths: 24", 30", 36", 42", 48"

Depths: 12", 13", 15", 16", 18",
20", 24", 26", 30", 32", 36"

Depths: 12", 15", 18", 24", 30", 36"

Heights: 19 $\frac{1}{2}$ ", 21", 22 $\frac{1}{2}$ ", 25 $\frac{1}{2}$ ", 27",
28 $\frac{1}{2}$ ", 30", 31 $\frac{1}{2}$ ", 33", 34 $\frac{1}{2}$ ", 36"



Oversized Dividers

Use Oversized Dividers to variably segment shelves. Three points of contact, two in Slotted Shelf and one at back hold Dividers in place.

Depth: 24"

Height: 12", 18"

Oversized Dividers can be used ONLY with 24" slotted shelving.



Garment Cabinet

The Garment Cabinet has 5 shelf openings for general storage and 1 Garment Rack. Features round contemporary locking handle.

Width: 36"

Depth: 24"

Height: 76 $\frac{1}{4}$ "

Consult Design Support for additional sizes.



Combination Unit

This unit is preconfigured with 3 locking drawers for hanging files along with 3 open tiers for general storage.

Available as Starter and Add-on units.

Width: 36"

Depth: 15"

Height: 76 $\frac{1}{4}$ "

Consult Design Support for additional sizes.

AURORA ACCESSORIES

Accessories create an endless variety of arrangements for any job, from light to heavy... tool rooms and shop parts, storage, display units, vault, and file storage.



Quik-Door™ Hinged Doors

Need secure general storage or filing? The Quik-Door can provide it. Locking doors pivot nearly flush with unit sides to make storage easy. The Extension Kit allows you to accommodate end tab filing and secure files for HIPAA compliance.

Door Widths:
24", 30", 36", 42", 48"



Sliding Doors

36" Wide doors are available in 72" 2-wide, and 108" 3-wide sets, complete with top and bottom track, and one lock that locks all doors in a set. Sliding Doors contain preassembled rollers that give effortless operation, and cannot "clog."



Quik-Door™ Security Doors

The locking Quik-Roll installs on new Aurora Shelving or retrofits to existing Aurora Shelving within minutes. Your materials stay in place, no need to unload.

Lock the unit with a single push-button lock, unlock the system and the counterbalanced door gently springs up. How's that for 'quik' security and HIPAA compliance for files.

Widths: 24", 30", 36", 42", 48"



Retractable Doors

Outfit Retractable Doors on 15" deep Aurora Shelving for letter filing and 18" deep Aurora Shelving for legal filing. Optional locks available.

Door Widths: 24", 30", 36",
42", 48"



Divided Storage Drawers

Divided Storage Drawers with and without security locks are available in the following dimensions:

Depths: 15", 18", 24"
Heights: 4½", 6", 7½", 9",
10½", 12"



Rollout Filing Drawers

Filing Drawers for top tab filing are designed to be used in 15" deep shelving for letter filing and 18" deep shelving for legal filing, or 24" deep shelving for front-to-back filing. Drawers are available with and without security locks.

Double interlock secures the drawer allowing only one drawer to be opened at a time for safety. See configuration chart for partitioning Storage Drawers (pg. 26).

Drawers can be configured with Converter Bars for letter-to-legal and front-to-back filing. Double interlock secures the drawer allowing only one drawer to be opened at a time for safety. See configuration chart on page 24 and 25.

Drawers that are 12" high are used for standard filing applications. Shorter Filing Drawers can also be used for specialty filing or general storage.

Heights: 4½", 6", 7½", 9", 10½", 12"
Widths: 24", 30", 36", 42", 48"



Leveler Foot

Slides into Shelving Uprights and allows leveling on uneven floors.

Magnetic Follower

This accessory helps to keep media upright.

Size: 6¾" W x 7½" H



Aisle Tie

Position Aisle Tie in opposing T Uprights overhead to secure shelving across an aisle.

Available in three sizes:
36", 42", 48" aisle widths.

Plastic Feet

Four for each T Upright (two for L Uprights) fit into the bottom of post to prevent damage to floors and carpets.



Adjustable Aisle Tie

The Adjustable Aisle Tie is used when an application calls for aisles that are not typical or standard width. This special Aisle Tie can be adjusted on one-inch centers to change the size of an aisle. This flexibility can allow for an extra row of shelving or can accommodate design challenges such as working around a column.

Adjusts from 36" - 60".

Shelf Reinforcement

Used to prevent deflection of the shelf and evenly distributes the weight load.

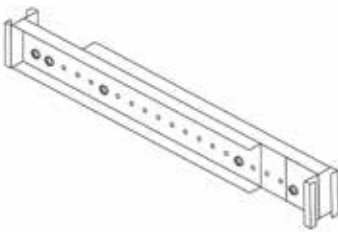

Wall Tie

Ties shallow sections of shelving to wall. Adjustable to compensate for molding if necessary. One every other post is ample.



Card Holder

A: Vertical Card Holder

B: Horizontal Card Holder

Card Holders attach to shelving end panels with double adhesive tape and have channels to accept removable cards (not supplied) to easily identify shelving aisles for content.

Wall Mounted Shelving

Two-tier wall mounted cabinets with non-slotted or slotted shelving on 15" centers. Slotted shelves include file dividers. Cabinets must be mounted to wall studs.

Dimensions:
36" W x 15" D x 31.63" H



A

B

Quik-Base™

A multifunctional component that acts as shelf support, front base and floor anchor all in one.

Mounting anchors not included.

Heights: 2¾", 4¼"
Widths: 24", 30", 36", 42", 48"

U Clip

Grips open uprights together on back-to-back open shelving. Two recommended for each pair of back-to-back posts.



Clothespin

Grips closed uprights together on back-to-back closed shelving. Use one in top of each pair of back-to-back posts.



STEEL FRAMES PLUS PLYWOOD SHELVES

The Economical Answer for Light Loads

Moderate to lightweight loads can be stored efficiently and economically using Aurora Shelving Uprights and Shelf Supports in combination with plywood or chipboard shelves which can be purchased locally. This is an excellent approach for reducing costs in the storage of soft goods, lightweight parts, and similar loads.

Shelf Supports

STANDARD - 11/4" High, 14 Ga. and 11 Ga. (5/8" plywood and 3/4" plywood shelves shown)

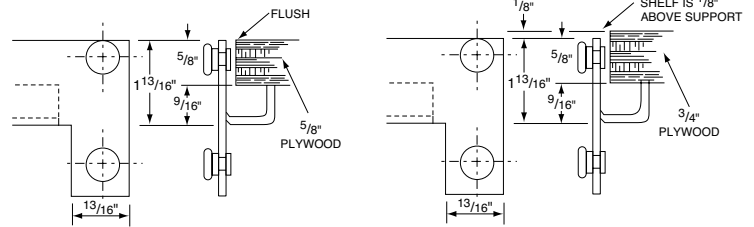

SINGLE ROW SHELF SIZES

Nominal Depth	Actual Depth
12"	10 ^{13/16} "
15"	13 ^{13/16} "
18"	16 ^{13/16} "
24"	22 ^{13/16} "

Nominal Width	Actual Width
36"	35 ^{3/4} "
42"	41 ^{3/4} "
48"	47 ^{3/4} "

DOUBLE ROW SHELF SIZES

Nominal Depth	Actual Depth
24"	22 ^{7/8} "
30"	28 ^{7/8} "
36"	34 ^{7/8} "
48"	46 ^{7/8} "

Nominal Width	Actual Width
36"	33 ^{15/16} "
42"	39 ^{15/16} "
48"	45 ^{15/16} "

TYPICAL PLAN VIEW

Single Row Units with Plywood Shelves.

NOTE: On single row units where backs are used, back holders or clips are recommended.

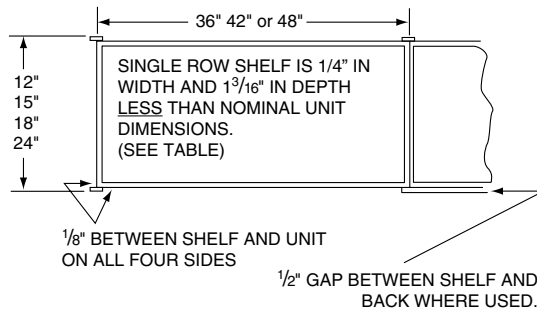

TYPICAL PLAN VIEW

Double Row Units, Back to Back with Plywood Shelves.

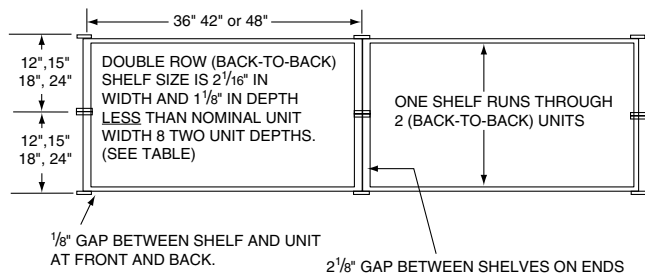

Tie back-to-back units together with Clothespin or U-clips. These fasteners are recommended for each pair of Uprights ordered.

Note that only three Shelf Supports are recommended for each shelf. Only one support is required in the shelf center where the back-to-back units meet providing another savings in materials. There is no loss in rigidity.

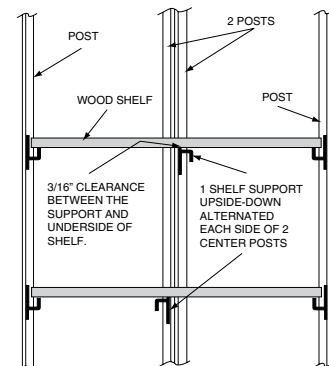

Depth (side) Section of Two Back-to-Back Units (with one chipboard shelf through both)

AURORA LIBRARY SHELVING

The ideal choice for Corporate, Professional, and Public Libraries

Today's libraries must be multi-functional and space efficient with an appealing design. The incredible flexibility of Aurora Library Shelving makes it the system of choice for modern libraries.

Architects and designers appreciate the ease with which Aurora Library Shelving adapts to custom applications with loads of library accessories for every need.



Wood-Tek™ Library Shelving

Aurora also features a line of elegant wood-clad library shelving. Wood-Tek has the warmth of wood with the strength of steel provided by the underlying shelving. Order Wood-Tek in two species and four elegant stains or custom species and stains to match your project. Wood-Tek Accessories such as conference tables, atlas stands, and study carrels can be created to match our Wood-Tek Library Shelving.



THE SMART CHOICE FOR BOOK STORAGE

Why settle for cantilever shelving for book storage when you can have Aurora Library Shelving? Aurora Library Shelving features a unique design that's easy to assemble, reconfigures in a snap, and eliminates the problems of book storage common to cantilever-style shelving.

THE 4-POST VS. CANTILEVER DEBATE

WHY A COMMON SOLUTION IS NOT NECESSARILY THE BEST SOLUTION



VS



FEATURES	AURORA 4-POST	CANTILEVER
AESTHETICS	Shelving comes with steel end panels for a clean and polished look.	Open cantilever has unfinished look End panels are a purchased option.
COMPACT FOOTPRINT	Saves floor space and provides more storage than similar sized cantilever unit.	Add 2" – 2½" to unit depth to accommodate posts.
BOOK DAMAGE PREVENTION	Gusseted uprights provide smooth inner sidewalls so books do not slide or lodge behind uprights.	Shelves can exhibit lateral movement away from slots in cantilever uprights causing the material to catch between end bracket and upright.
ADJUSTABILITY OF SHELVES	Individually adjustable per side on back-to-back units.	Individually adjustable per side.
SIZE SELECTION	Available in 5 widths and 11 depths, more than cantilever shelving.	Limited to a maximum of 36" width for most manufacturers.
COLLECTION NCLEANLINESS	Top canopy shelf is standard, protecting books from dust and water damage from accidental fire sprinkler discharge.	Open top is standard. Canopy is non-standard purchased option.
MOBILE READY	Anchors easily to mobile carriages with no loss of stability or additional hardware.	Must be reinforced with gussets on alternate uprights to make mobile ready, adding to system costs.
SINGLE UNIT STABILITY	Rigid uprights and shelf reinforcements make even a single section of shelving stable.	Lateral racking can occur.

AURORA LIBRARY SHELVING SELECTION GUIDE

Aurora's special Library Upright with double wall construction allows easy access to books in even tightly packed rows. And equally important, it provides a smooth inner wall to prevent books from lodging behind the uprights which can be an issue with cantilever library shelving.



Shelves

Two styles of shelves are available for Library Shelving, Solid and Slotted for use with dividers to separate material such as brochures, sheet music, pamphlets, and binders.

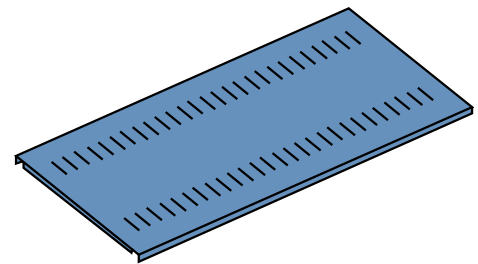
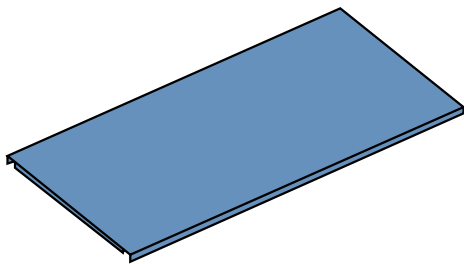

Shelving Sizes

22 SIZES

5 Widths

24", 30", 36", 42", 48"

9 Depths

9", 10", 12", 13", 16", 18", 20", 24", 26"

8 Heights

40 $\frac{1}{4}$ ", 64 $\frac{1}{4}$ ", 76 $\frac{1}{4}$ ", 85 $\frac{1}{4}$ ", 88 $\frac{1}{4}$ ", 97 $\frac{1}{4}$ ", 100 $\frac{1}{4}$ ", 121 $\frac{1}{4}$ "

LIBRARY CONFIGURATION STYLES

Closed back, open back, double entry, back to back? It's your choice depending on your requirements.



Single Entry Open Back

- Front access.
- Shelving Backstops hold media in place.
- Shelves adjustable on 1½" centers.



Single Entry Closed Back

- Front access.
- Back Panel holds media in place.
- Shelves adjustable on 1½" centers.



Back-to-Back

- Access from either side.
- Back Stop holds media in place.
- Independent shelves on each side are adjustable.
- Shelves adjustable on 1½" centers.



Double Entry

- Access from either side.
- Single double depth shelf with Center Stop can be adjusted on 1½" centers.

HOW TO ORDER LAMINATES FOR LIBRARY SHELVING

Laminate Countertops

Many libraries and media centers prefer countertop high shelving in children's areas, teaching pods, maker spaces or reference sections. In these cases, you'll need to order a laminate countertop for 41 1/4" high library units along with special uprights with flanges to accept the countertop. We recommend that you send a floor plan to ensure accuracy.

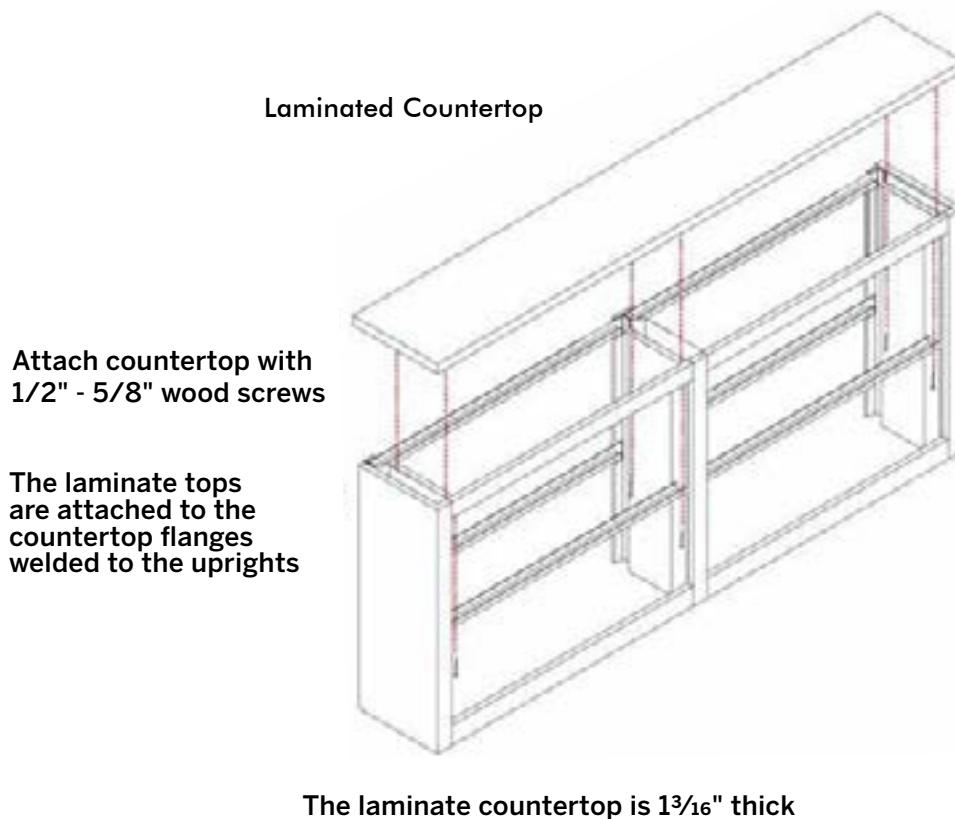

Countertop Dimensions

Unless specified differently on your drawing, here are the standard dimensions Aurora provides on laminated countertops.

Thickness: 1 1/4"

Overhang: 1/2" on any edge not against a wall.

Maximum Length: 10' for a continuous laminate counter. Any installations with longer length shelving will have a spliced laminate countertop.

Although freestanding countertop units are the most commonly designed, see the following diagrams for various other configurations.

LAMINATE COUNTERTOPS

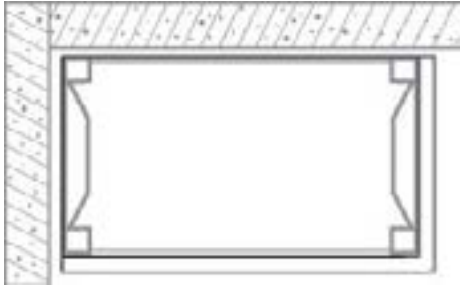

Laminate Countertop
Finished Front and Right Side

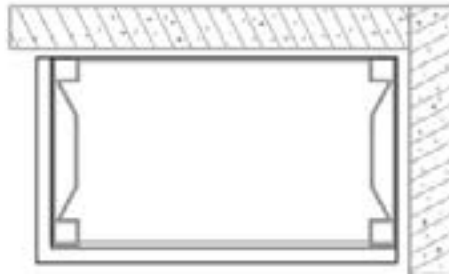

Laminate Countertop
Finished Front and Left Side

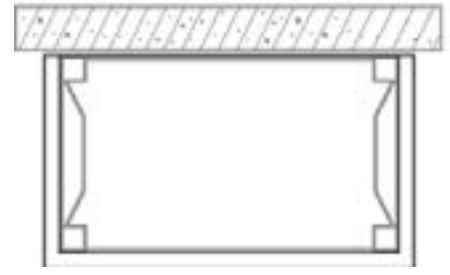

Laminate Countertop
Finished Front & Sides

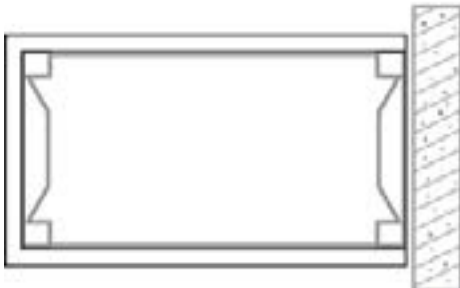

Laminate Countertop
Finished Front, Back, and Left Side



Freestanding Unit
Laminate Countertop
Finished on All Sides

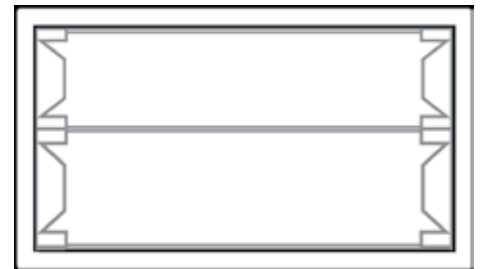

Back-to-Back Freestanding Units
Laminate Countertop
Finished on all Sides

Laminate End Panels & Backs

The beauty of Aurora Library Shelving is its versatility to match interior design elements with color and end panel treatments. Slat wall, ever so popular in libraries, can be added to shelving end panels and back walls. Standard laminates are also a great decorative touch for end panels. Laminates are created as 'filler' panels fitted into a special T-style upright. The suffix - WTS should be used for when ordering. Pictured below is how the laminated filler panel fits into the Library Upright or Standard Shelving Upright.

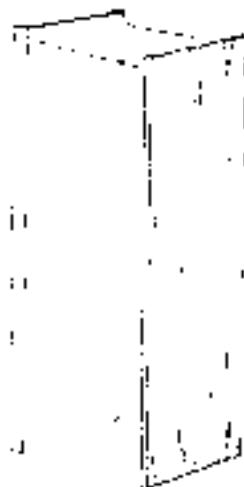

Panel adds 1" on each end.

CLOSED T UPRIGHT



Laminated Filler Panel
(Top View)

LIBRARY UPRIGHT Inner Wall

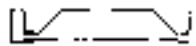

Laminated Filler Panel
(Top View)

AURORA LIBRARY SHELVING ACCESSORIES



Browser Boxes & Dividers

Browser Boxes are designed to hold DVD's, Tapes, CD's, Video Cases, etc. Dividers shown in the image (inset right) must be specified separately.

Drawer Widths: 30", 36", 42", 48"

Drawer Heights: 4", 6"

Drawer Depths: 12", 15"

Dividers run front-to-back and are ordered separately in these sizes.

Divider Heights: 4", 6"

Divider Depths: 12", 15"



Book Display Shelf & Cap

Double-sided top shelf for displaying books, comics and more on library shelving. Front 2" edge holds media in place and gentle slope provides great visibility.

Order Upright Caps separately.

Widths: 24", 30", 36", 42", 48"

Depths: 12", 15", 18", 24", 30", 36"



Aurora Library Carts

The Aurora Library Cart is a double-sided book transport cart with three 24" deep shelves and three center stops that create six openings (three 12" deep openings on each side). Four 4" gray poly casters are each rated at 250 lbs; two casters swivel with locking brakes and two are rigid casters.

Carts come with several style options including a steel top, a laminate top, and laminate top and laminate sides to match.

Dimensions: 36"W x 24"D x 45.38"H Steel Top

36"W x 24"D x 46.5"H Laminate Top Models

Weight Capacity: 1000 lbs

Storage Capacity: Approximately 17 cubic feet of storage space



Hanging Brackets

Organize games, puzzles, and audio/book combos with Hanging Brackets used on non-library uprights. Includes:

- 2 special shelf supports
- 2 front-to-back brackets
- 1 pole

Widths: 24", 30", 36", 42", 48"

Depths: 12", 15", 18", 24", 30", 36"

AURORA LIBRARY SHELVING ACCESSORIES



Slat Wall

Order custom laminate Slat Wall to display books, brochures, pamphlets, magazines, and meeting notices. Perfect for Library End Panels or Shelving Backs.



Sloping Shelf

Display current periodicals or brochures on this fixed Sloping Shelf.

Widths: 24", 30", 36", 42", 48"



Magazine Door

Creates an attractive display area for magazines plus ample storage space for old issues. Door swings up easily for quick access to storage area.

Widths: 24", 30", 36", 42"



Reference Shelf

A handy retractable work surface can be added to library shelving. The Reference Shelf slides out to use and tucks back under the shelf when not in use.



Media Shelf

Media Shelf slants to store DVDs, CD, tapes on two sides of unit. For use with Library Uprights 9" and 16" deep.

Widths: 24", 30", 36", 42", 48"
Height: 4½"



Wire Book Support

Snaps in quickly and holds books firmly in place. Use with 3/4" TS Support.



Magnetic Follower

Use this magnetized accessory to keep books and other media upright on a shelf.

Dimensions: 6¾"W x 7½"H



Dividers

Dividers section shelves and hold books or media upright.

AURORA SHELF FILING FOR EFFICIENT, ECONOMICAL STORAGE

Gain all the advantages of open shelf filing...fast accessibility, greater visibility of filed materials, better use of space and overall economy...with unique Aurora Shelf Filing.

Only Aurora Shelving units offer you these features:

- Fast, easy, no-tool assembly by hand—no screws, bolts, clips or other fasteners needed for basic shelving units.
- Unmatched strength and rigidity without sway braces.
- Available in more heights, depths, and widths than any other manufacturer. Custom heights and widths.
- All surfaces are finished in Gloss-Tek™ a powder coat that is eco-friendly with no VOCs (Volatile Organic Compounds).
- Maximum visibility and access for both single entry and double entry installations.
- No worry about snagging folders on braces or fasteners.
- Slip-in dividers fit slotted shelves, can be easily changed or removed—excellent for all types of open filing.
- The truly simplified system—fewer parts than bracket type shelving.

Foot by foot, Aurora Shelf units are your best shelf filing buy

22 SIZES

5 Widths

24", 30", 36", 42", 48"

9 Depths

9", 10", 12", 13", 16", 18", 20", 24", 26"

8 Heights

40¼", 64¼", 76¼", 85¼", 88¼", 97¼", 100¼", 121¼"

File Divider Installation for Single & Double Entry Shelving

DIVIDER MOUNTING DETAILS

Single Entry — SHELF FILING

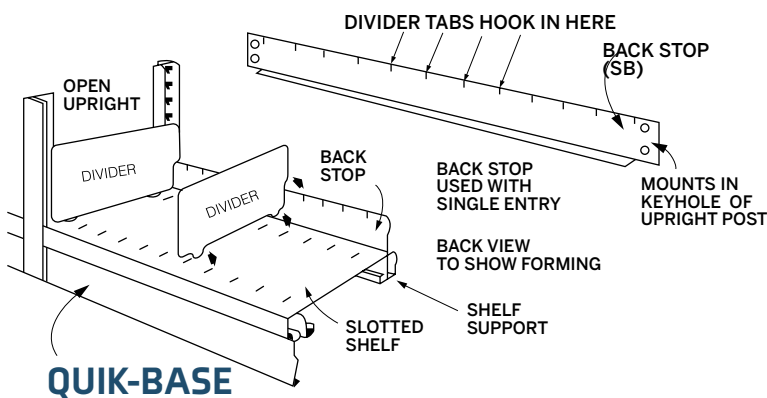

Double Entry — SHELF FILING

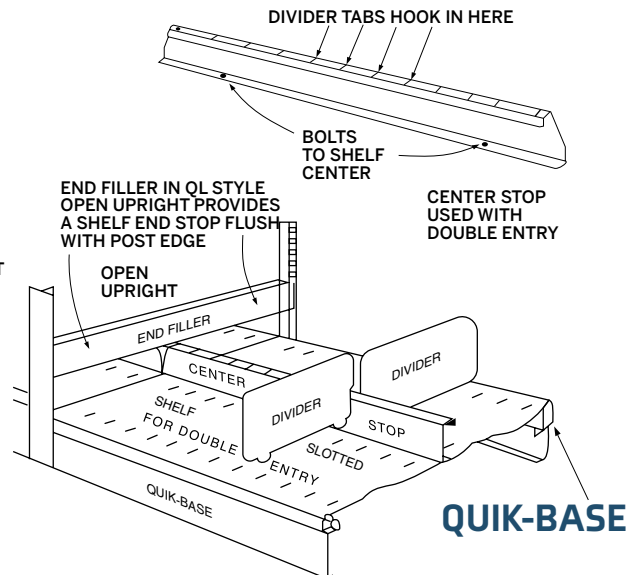

AURORA X-RAY SHELVING FOR UNMATCHED STRENGTH AND EASY ACCESS

The Aurora Shelving design benefits are available for X-Ray storage. The complete lack of nuts, bolts, clips or sway braces eliminates the most common causes of snagged and torn X-Ray jackets. Fastest assembly is assured, and no tools are needed. The superb strength means that Aurora Shelving easily withstands the heavy loading of X-Rays and maintains excellent rigidity.

X-Ray Shelving Configurations

Single and Double Entry Configurations are offered as Starters and Add-on Units and can be ordered with closed or open backs. Units come complete with Uprights, Quik-Base, Shelves, Shelf Supports, Reinforcements, Dividers and Back or Center Stops. Mobile ready versions.

X-Ray Shelving Dimensions

Widths: 36", 42", 48"

Depths: 15", 18", 30", 36"

Height: 88 $\frac{1}{4}$ "



Typical 36" wide Aurora X-Ray section is 88 $\frac{1}{4}$ " high with six shelves and five openings. Standard assemblies include three File Dividers for each opening and two Reinforcements per Shelf (except the Top Shelf).



X-Ray Dividers

Although X-Ray units come complete with Dividers, additional Dividers in several heights and depths can be ordered for Single Entry and Double Entry X-Ray Shelving. Bottom tabs at front and back hook into Slotted Shelf and tab at back hooks into Back or Center Stop.

AURORA SHELF FILING COMPONENTS

Unit shelves are spaced on 10¹/₂" centers for standard filing with a 9³/₄" clear opening and are adjustable on 1¹/₂" centers.

Adding a Reference Shelf to Filing Units adds 1¹/₂" to the requirement. A single 12 inch shelf spacing in the unit is required for a Reference Shelf. Standard Units that are 76¹/₄" and 97¹/₄" in height will require front and back Single Rivet Supports at the bottom to accommodate a Reference Shelf. Our 64¹/₄" high units come standard with Single Rivet Shelf Supports at the bottom, however the unit can only accommodate a Reference Shelf if it is acceptable to lose one standard filing opening. This shorter opening can be used for general storage.



Quik-Base™

Quik-Base streamlines shelving installation by combining a front base, shelf support and floor anchoring device in one assembly. Quik-Base is firmly attached to the uprights with our patented Quik-Lok system so it won't move if accidentally kicked or bumped. Comes in 2³/₄" and 4¹/₄" heights.



Center Stop

Used in double entry units and is fastened to shelves with nuts and bolts. Finger tighten first. Put in a couple of Dividers and adjust Center Stop so Dividers are straight, then tighten nuts and bolts.



Slotted Back Stop

Used in single entry units with tabs going into first and second full keyholes above the shelf.



Reinforcements

Install before placing shelf over supports. Hook Reinforcements over support flanges about 8" in from the end of support.



File Dividers

Install by putting shoe tab into front shelf slot then lower back tab into slot of center or back stop and bottom tab into back slot of shelf. One File Divider is used on each end of shelf and the rest may be adjusted as needed.



Reference Shelf

Creates a handy retractable surface that can be added to shelving. The Reference Shelf slides out to use and tucks back under the shelf when not in use.

FILING DRAWER CONFIGURATION CHART

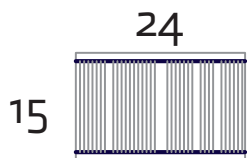

Item Number: 24RLP00
Letter 2-Rail Pack

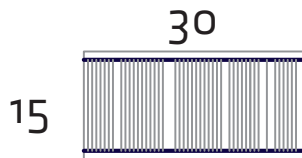

Item Number: 30RLP00
Letter 2-Rail Pack

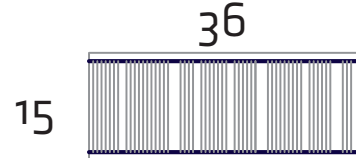

Item Number: 36RLP00
Letter 2-Rail Pack

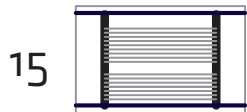

Item Number: 2415HF2-PK00
Letter 2-Rail Pack
2-Converter Bars

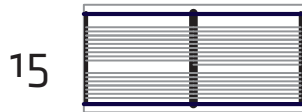

Item Number: 3015HF3S-PK00
Letter 2-Rail Pack
3-Converter Bars

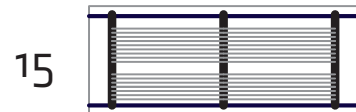

Item Number: 3615HF3-PK00
Letter 2-Rail Pack
3-Converter Bars

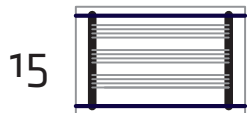

Item Number: 2415HF2-PK00
Legal 2-Rail Pack
2-Converter Bars

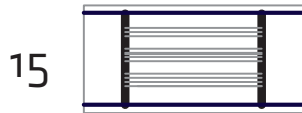

Item Number: 3015HF2-PK00
Legal 2-Rail Pack
2-Converter Bars

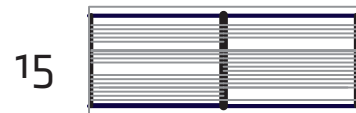

Item Number: 3615HF3S-PK00
Legal 2-Rail Pack
3-Converter Bars

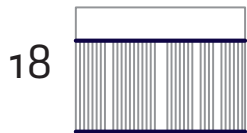

Item Number: 24RLP00
Letter 2-Rail Pack

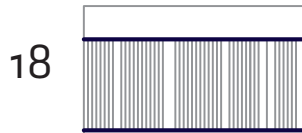

Item Number: 30RLP00
Letter 2-Rail Pack



Item Number: 36RLP00
Letter 2-Rail Pack

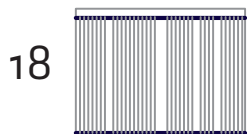

Item Number: 24RLP00
Legal 2-Rail Pack

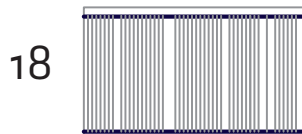

Item Number: 30RLP00
Legal 2-Rail Pack



Item Number: 36RLP00
Legal 2-Rail Pack

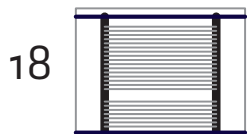

Item Number: 2418HF2-PK00
Letter 2-Rail Pack
2-Converter Bars



Item Number: 3018HF3S-PK00
Letter 2-Rail Pack
3-Converter Bars



Item Number: 3618HF3-PK00
Letter 2-Rail Pack
3-Converter Bars



Item Number: 2418HF2-PK00
Legal 2-Rail Pack
2-Converter Bars



Item Number: 3018HF2-PK00
Legal 2-Rail Pack
2-Converter Bars



Item Number: 3618HF3S-PK00
Legal 2-Rail Pack
3-Converter Bars

FILING DRAWER CONFIGURATION CHART

42

15

Item Number: 42RLP00
Letter: 2-Rail Pack

15

Item Number: 4215HF4-PK00
Letter: 2-Rail Pack
4-Converter Bars

15

Item Number: 4215HF3-PK00
Legal: 2-Rail Pack
3-Converter Bars

18

Item Number: 42RLP00
Letter: 2-Rail Pack

18

Item Number: 42RLP00
Legal: 2-Rail Pack

18

Item Number: 4218HF4-PK00
Letter: 2-Rail Pack
4-Converter Bars

18

Item Number: 4218HF4-PK00
Legal: 2-Rail Pack
4-Converter Bars

48

15

Item Number: 48RLP00
Letter: 2-Rail Pack

15

Item Number: 4815HF4-PK00
Letter: 2-Rail Pack
4-Converter Bars

15

Item Number: 4815HF3-PK00
Legal: 2-Rail Pack
3-Converter Bars

18

Item Number: 48RLP00
Letter: 2-Rail Pack

18

Item Number: 48RLP00
Legal: 2-Rail Pack

18

Item Number: 4818HF4-PK00
Letter: 2-Rail Pack
4-Converter Bars

18

Item Number: 4818HF3-PK00
Legal: 2-Rail Pack
3-Converter Bars

DIVIDED DRAWER CHART

DRAWER SIZE		CLEARANCE		USABLE AREA (INSIDE DIMENSIONS)				
DRAWER HEIGHT	DRAWER DEPTH	HEIGHT	DEPTH	24" Wide	30" Wide	36" Wide	42" Wide	48" Wide
				WIDTH	WIDTH	WIDTH	WIDTH	WIDTH
4.5"	15	2.77	12.79	19.87	25.87	31.87	37.87	43.87
	18		15.79					
	24		21.79					
6"	15	4.27	12.79					
	18		15.79					
	24		21.79					
7.5"	15	5.77	12.79					
	18		15.79					
	24		21.79					
9"	15	7.27	12.79					
	18		15.79					
	24		21.79					
10.5"	15	8.77	12.79					
	18		15.79					
	24		21.79					
12"	15	10.27	12.79					
	18		15.79					
	24		21.79					

NUMBER OF OPENING	DRAWER DEPTH	CLEARANCE	USABLE AREA BETWEEN PARTITION (Right to Left)				
		DEPTH	24" Wide	30" Wide	36" Wide	42" Wide	48" Wide
			WIDTH				
3	15	12.79	6.3	8.3	10.3	12.3	14.33
	18	15.79					
	24	21.79					
4	15	12.79	4.63	6.13	7.63	9.13	10.63
	18	15.79					
	24	21.79					
5	15	12.79	3.62	4.82	6.02	7.22	8.42
	18	15.79					
	24	21.79					
6	15	12.79	2.94	3.9	4.94	5.94	6.94
	18	15.79					
	24	21.79					
8	15	12.79	2.09	2.84	3.59	4.34	5.09
	18	15.79					
	24	21.79					

Weight Load: Slides are rated at 180 pounds per pair.

SHELVING ADJUSTABILITY

Shelves are adjustable on 1/4" increments.

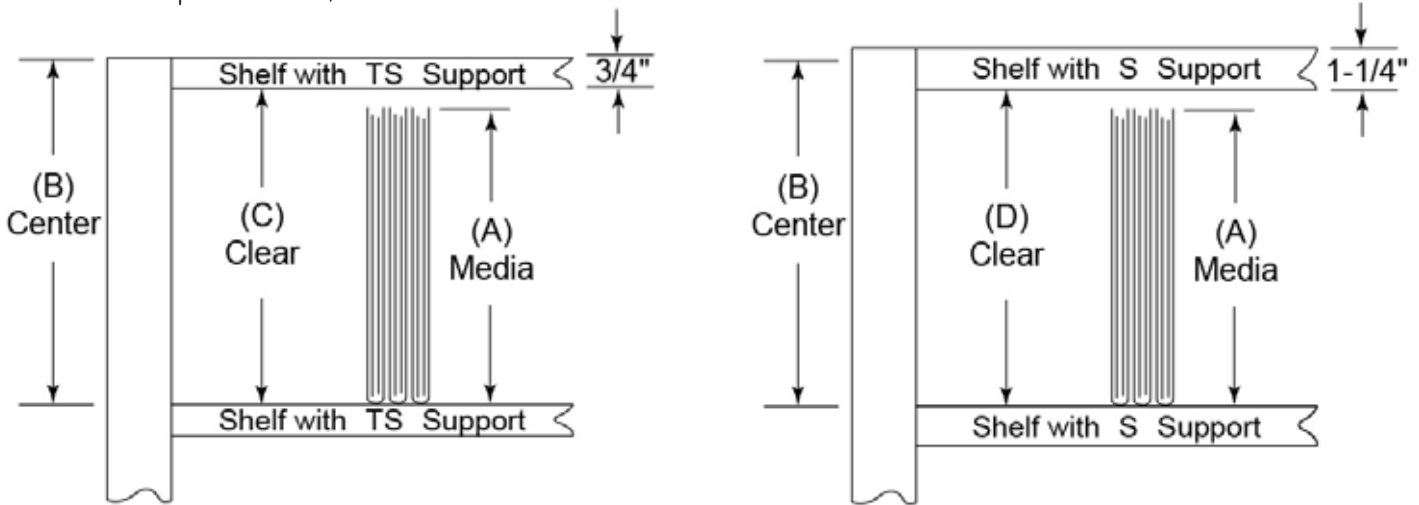

MEDIA SIZES

Media (A)	Height
CD/DVD.....	4 ³ / ₄ "
Top Tab Folders.....	9 ¹ / ₂ "
End Tab Folders.....	9"
Banker's Boxes.....	10"
Video Tapes	8"
Books	10"
Binders.....	11 ¹ / ₂ "
X-Rays.....	15"

CENTERS AND CLEAR DIMENSIONS

Center (B)	Clear Opening	
	TS Supports (C)	S Supports (D)
6"	5 ¹ / ₄ "	4 ³ / ₄ "
7 ¹ / ₂ "	6 ³ / ₄ "	6 ¹ / ₄ "
9"	8 ¹ / ₄ "	7 ³ / ₄ "
10 ¹ / ₂ "	9 ³ / ₄ "	9 ¹ / ₄ "
12"	11 ¹ / ₄ "	10 ³ / ₄ "
13 ¹ / ₂ "	12 ³ / ₄ "	12 ¹ / ₄ "
15"	14 ¹ / ₄ "	13 ³ / ₄ "
16 ¹ / ₂ "	15 ³ / ₄ "	15 ¹ / ₄ "

FILING INCH / SQUARE FOOTAGE COMPARISON CHART

LATERAL FILES				
UNIT	SIZE	L.F.I.	SQUARE FT. USAGE	
2 Drawer	36"W	66" L.F.I.	36W = 8 ¹ / ₄	
2 Drawer	42"W	78" L.F.I.	42W = 9 ⁵ / ₈	
3 Drawer	36"W	99" L.F.I.		
3 Drawer	42"W	117" L.F.I.		
4 Drawer	36"W	132" L.F.I.	NOTE: Square	
4 Drawer	42"W	156" L.F.I.	Footage Usage	
5 Drawer	36"W	165" L.F.I.	Includes Drawer	
5 Drawer	42"W	195" L.F.I.	pull out.	
VERTICAL FILES				
UNIT	SIZE	L.F.I.	SQUARE FT. USAGE	
2 Drawer	Letter or Legal	50" L.F.I.	Letter =6 ¹ / ₄ Legal =7 ¹ / ₂	
3 Drawer	Letter or Legal	75" L.F.I.		
4 Drawer	Letter or Legal	100" L.F.I.		
5 Drawer	Letter or Legal	125" L.F.I.		
SHELF FILES W/ DOORS				
UNIT	SIZE	L.F.I.	SQUARE FT. USAGE	
5 Tier	36"W	170 L.F.I.	Letter =3 ¹ / ₃ Legal =4	
6 Tier	36"W	204 L.F.I.		
7 Tier	36"W	238 L.F.I.		
4 - POST SHELVING SYSTEMS				
UNIT	SIZE	L.F.I.	SQUARE FT. USAGE	
			Letter	Legal
6 Opening	36"W	204 L.F.I.	3	3 ³ / ₄
6 Opening	42"W	240 L.F.I.	3 ¹ / ₂	4 ³ / ₈
6 Opening	48"W	276 L.F.I.	4	5
7 Opening	36"W	238 L.F.I.	3	3 ³ / ₄
7 Opening	42"W	280 L.F.I.	3 ¹ / ₂	4 ³ / ₈
7 Opening	48"W	322 L.F.I.	4	5
8 Opening	36"W	272 L.F.I.	3	3 ³ / ₄
8 Opening	42"W	320 L.F.I.	3 ¹ / ₂	4 ³ / ₈
8 Opening	36"W	368 L.F.I.	4	5



Aurora Storage has Shelving Systems for Every Need from Team Athletic Equipment to Law Enforcement Weapons Storage.



AURORA

A SOLUTION FOR EVERY STORY

Aurora Storage
600 South Lake Street • Aurora, IL 60506
Ph: 630-897-6951 • Fax: 630-897-6994
Toll Free: 800-277-1699
www.aurorastorage.com

All Rights Reserved Copyright © 2019
SPG06-18 1M



Contract Holder
Contract GS-25F-0084M

U.S. Small Business Enterprise



For more information go to:
www.aurorastorage.com

For design assistance:
designsupport@aurorastorage.com